

Sharman's Sewing Centers

112A Johnston St
Longview, TX 75601
903-753-8014

6005 S. Broadway
Tyler, TX 75703
903-581-5470

Sewing Club – August 2020 (the Facebook Edition)



This is a great gift for the family (and Christmas is not too far away) – there are 5 game stations on this quilt – they stations can be made separately or 1 large project (if you make in separate pieces – you can spread over several gifting opportunities) . Weather too bad to go out – throw this on the floor and have some fun. In Part 1 – you will create the game boards. Next month we will cover – Part 2 – which will be the Storage Bag, Zipper bags for playing pieces and game pieces to make. The instructions will cover the fabric colors that were chosen for the sample – but make this your own and add your favorites. Have Fun!!!!

All seam allowances are ¼” Finished Size approximately 62” x 74”

Supplies Needed: *(These are for 1 large project – it will vary if you make each game board separately)*

Fabric	Qty	Where being used	Cut
Black Grunge	2 yds	Sashing between games Applique numbers in Hop Scotch Binding	12 – 2 ½” x wof Strips – sew together – end to end <i>Will get cuts as needed</i> See instructions on Hop Scotch Cut either Straight of the Grain or Bias for binding
White	1 1/3 yds*	Base Twister Blocks <i>*If in the hoop applique will need more fabric – 2 yds</i>	Cut 20 – 9” squares
Blue	1 yd	Hopscotch, Twister & Checkers	See each section for cutting
Yellow	1 yd	Hopscotch, Twister & Checkers	See each section for cutting
Red	1 yd	Hopscotch, Twister, Card Game	See each section for cutting
Green	1 yd	Hopscotch, Twister, Card Game	See each section for cutting
Orange	½ yd	Hopscotch, Tic-Tac-Toe	See each section for cutting
Brown	½ yd	Hopscotch, Tic-Tac-Toe	See each section for cutting
Purple	1 yd	Hopscotch, Checkers, Card Games	See each section for cutting
Sky Blue	5/8 yd	Hopscotch, Tic-Tac-Toe	See each section for cutting
Hot Pink	1/3 yd	Hopscotch	See each section for cutting
Chalkboard Vinyl	¼ yd	Scoreboard	
Steam a Seam 2® Fusible Web	1-2 yds	Hopscotch, Card Game	
Batting	64” x 76”		
Backing	4 ½” yds		

Plus, Threads and Tear away stabilizer

Sharman's Sewing Centers

112A Johnston St
Longview, TX 75601
903-753-8014

6005 S. Broadway
Tyler, TX 75703
903-581-5470

HOP SCOTCH

There are several appliques on this piece – Applique patterns are at the end of the instructions. You can enlarge to desired size. When appliqueing – start with a slightly larger background piece – this will allow for any shrinkage or movement on the fabric. When finished appliqueing – remove tear away stabilizer, press well and then trim to final size.

Cutting Instructions:

Fabric Color	Position	Cut 1	Cut 2
Sky Blue	Side pieces for 6 & 3	4 – 9 1/2" x 5"	Na
Red	End piece w/ star	1 – 8" x 19"	7 1/2" x 18 1/2"
Red	#4	1 – 9" x 9"	8 1/2" x 8 1/2"
Green	Start piece w/footprints	1 - 7" x 19"	6 1/2" x 18 1/2"
Green	#8	1 – 9" x 9"	8 1/2" x 8 1/2"
Royal Blue	#7	1 – 9" x 9"	8 1/2" x 8 1/2"
Pink	#2	1 – 9" x 9"	8 1/2" x 8 1/2"
Orange	#1	1 – 9" x 9"	8 1/2" x 8 1/2"
Brown	#6	1 – 9" x 9"	8 1/2" x 8 1/2"
Purple	#5	1 – 9" x 9"	8 1/2" x 8 1/2"
Yellow	#3	1 – 9" x 9"	8 1/2" x 8 1/2"

- ◆ You will need scraps of Black (for numbers), Yellow (for Star) & Brown (for foot prints)
- ◆ 3/4 yd Steam a Seam 2® for appliques
- ◆ 1 – 1 1/2 yd Tear Away Stabilizer
- ◆ Embroidery Thread to match Appliques
- ◆ Thread for piecing

Sewing Steps:

1. Trace Appliques on to the side of the seam with lines. The designs have been reversed for this process. (because the Steam a Seam is added to the wrong side of the fabrics – designs needed to be reversed so they are correct on the fabric side).
2. Remove the paper side of the seam a seam and stick to the wrong side of the applique fabrics. Fuse with iron
3. Cut out appliques to the lines
4. Remove the paper backing on the Appliques and Fuse to the appropriate background piece.
5. Setting up your machine –
 - a. you can use a white bobbin thread for all the appliques – so that you just change to top thread to match fabrics.
 - b. Open-Toe Presser Foot is best for this
 - c. Zig Zag Stitch
 - i. Stitch Width 2.5-3.0
 - ii. Stitch Length .2-.4 (test to see what is best on your machine)
 - d. You will want a piece of Tear Away stabilizer behind each applique – it will be removed when finished – but will prevent problems while you are stitching.
6. If Applique is new – practice on a scrap piece first – here are some tips on pivoting with applique:

End Piece - Red Color:

1. Cut 8" x 20"
2. Applique Star
3. Final Trim 7 1/2" x 19 1/2"

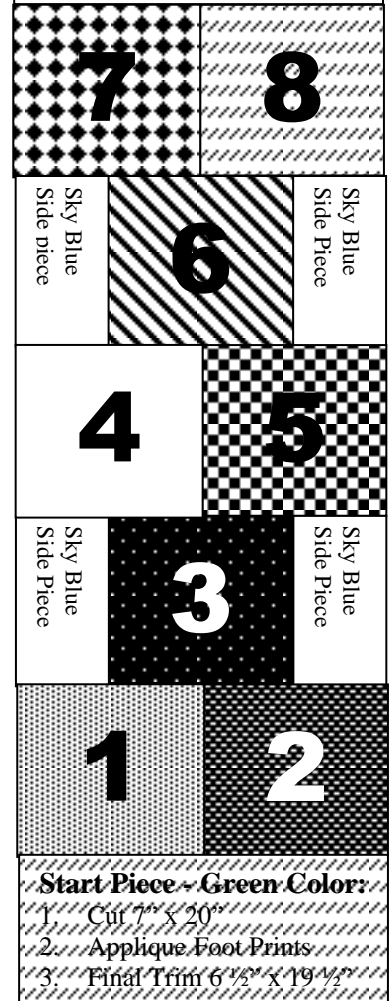

Start Piece - Green Color:

1. Cut 7" x 20"
2. Applique Foot Prints
3. Final Trim 6 1/2" x 19 1/2"



Sharman's Sewing Centers

112A Johnston St
Longview, TX 75601
903-753-8014

6005 S. Broadway
Tyler, TX 75703
903-581-5470

- Straight lines are the easiest to start with – make sure the bulk of the stitch is on the fabric – if you do not catch all the fabric you will have “eyelashes” beyond your stitching
 - Try corners next – you will want to keep the needle in the fabric for pivoting – when pivoting the outside of the corner – the needle needs to be on the outside edge of the fabric. For Inside corners – it needs to be on the inside edge.
 - Try Curve Next – this will take more gradual pivoting than the corners - Outside curves – stop with the needle on the outside – inside stop on the inside
 - Points can be fun – if you want an sharper point – taper the width of the stitch as you go into the point and taper back out as you come out. This may take a little practice – but can be mastered.
- When you have finished appliqueing all your pieces. Press well
 - Trim pieces to final sizes
 - Add the sky-blue pieces to either side of blocks #3 & #6. Press.
 - Add the rows together as illustrated. Press.
 - Your piece should now measure 18 ½” x 58 ½”.
 - Cut a piece of the black sashing fabric 58 ½” long and add to the left side of the hop scotch piece. Press
 - You are now done with the Hop Scotch piece – set aside for now.

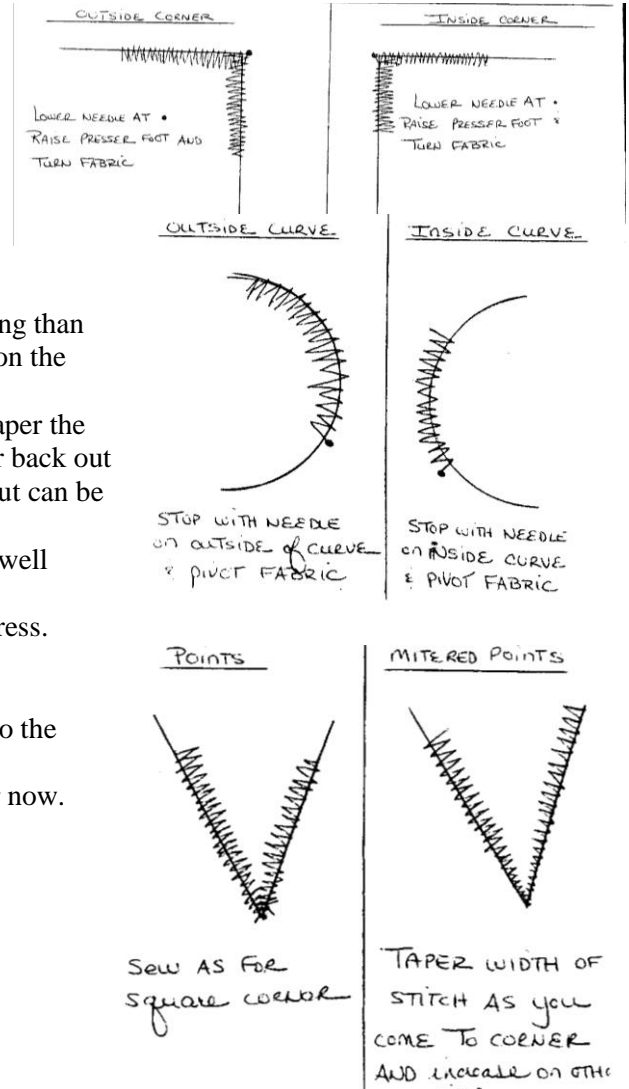

TIC-TAC-TOE

Supplies:

- ◆ 19” Square – Sky Blue Fabric
- ◆ 2 – 1 ½” x wof – Orange Fabric
- ◆ ¾” Fusible Bias Tape Maker
- ◆ Web for Fusible Bias Tape Maker

Sewing Steps:

- Sew the 1 ½” strips together – end to end
- Press the Strip thru the Bias Tape Maker with the fusible web
- Divide the Square in thirds. Press
- Fuse the Tape on the line.
- Using the Edge Joining or Narrow Edge Foot – topstitch on either side of the strips
- Trim the Block down to 18 ½” Square
- Add a 6 ½” x 18” Brown strip on the Left side of Tic-Tac-Toe. Press. (should measure 18 ½” x 24 ½”)
- Add a 24 ½” Black Sashing piece to the bottom. Press
You are now down with this piece – so set aside

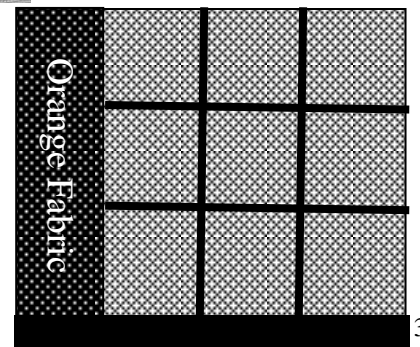
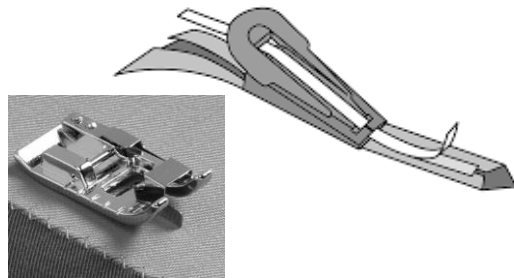

Sharman's Sewing Centers

112A Johnston St
Longview, TX 75601
903-753-8014

6005 S. Broadway
Tyler, TX 75703
903-581-5470

TWISTER

Supplies:

- ◆ 1 1/3 yd White Fabric (cut into 20 – 9” squares)
- ◆ 1/4 yd of each Red, Blue, Green & Yellow (cut 5 – 7” squares of each)
- ◆ 2 1/2 yd of Tear Away Stabilizer (20 – 8” squares)
- ◆ Circular Stitch Guide (or Sew Steady Table with Circular Guide)
- ◆ Embroidery thread to match each of the 4 colors
- ◆ Small pair of scissors for trimming

Because we need 20 perfectly round circles – this is a great time to use a circular guide attachment – or if you have the Deluxe Sew Steady Table – the small holes down the center are for circles. You could applique – but much more work.

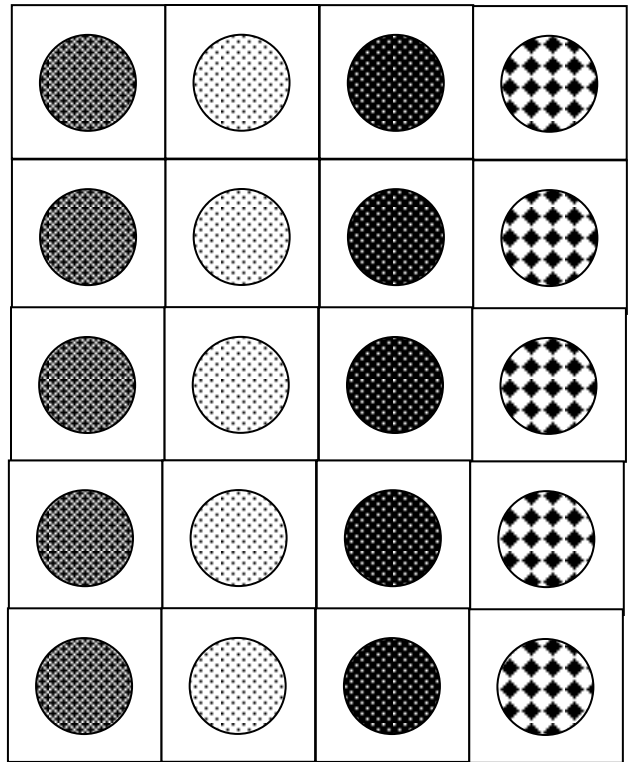
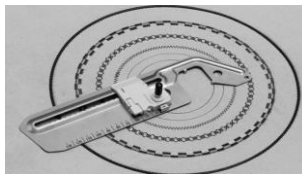

Sewing Steps:

1. A neutral Bobbin thread on bottom – matching embroidery thread on top to match circle fabric. You will need 5 blocks of each of the 4 colors. Open Toe Presser foot or Decorative Stitch Foot
2. Lightly press a Center mark in each of the color squares and the white squares
3. Attach the Circular Stitcher to the needle plate of your sewing machine
4. Adjust the guide to 3 inches – we want a 6” circle
5. Layer a square of Tear away stabilizer, white fabric and color square – all right sides facing up – place the pin (looks like a tack) thru the center you

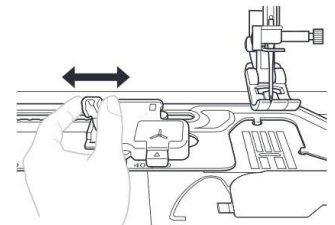
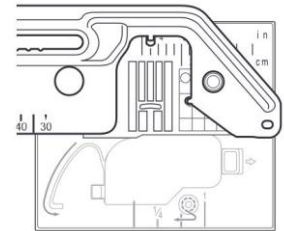

marked on each of the fabric and center as color as possible to tearaway

6. Place the pin into the holder on the circular stitcher. This allows the fabric stack to “spin” under the presser foot.
7. First round – you want to straight stitch – standard stitch length. When you

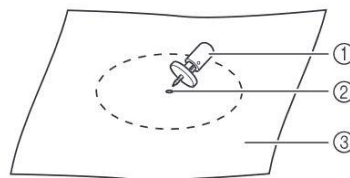

- ① Pivot Pin
- ② Center of circle
- ③ Right side of Fabric

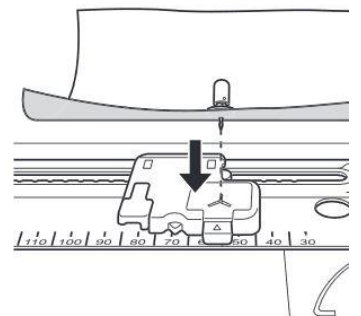

Sharman's Sewing Centers

112A Johnston St
Longview, TX 75601
903-753-8014

6005 S. Broadway
Tyler, TX 75703
903-581-5470

complete the circle – stop sewing – but do not remove fabric from machine

8. Raise the presser foot and “spin” the fabric around – this time trimming the excess fabric away from the stitching.
9. When you have the “circle” of color fabric – switch the stitch to a Zig Zag (or the Satin Stitch Zig Zag) Stitch Width 2.5-3.0 & Stitch Length .2-.4 (test to see what is best on your machine)
10. Satin Stitch the Circle now.
11. When you have finished the circle – remove from machine. Remove Stabilizer and press Well.
12. Final Trim Block to 8 ½” Square.
13. Continue to make the Blocks – you will need 5 of each color –
14. Sew the blocks together - each color is in a row – Blue, Yellow, Green, Red. 5 Rows Total. Press (should measure 32 ½” x 40 ½”)
15. At bottom of the Twister Board – add a 32 ½” x 2 ½” black sashing piece. Press. You are done with section – set aside for now

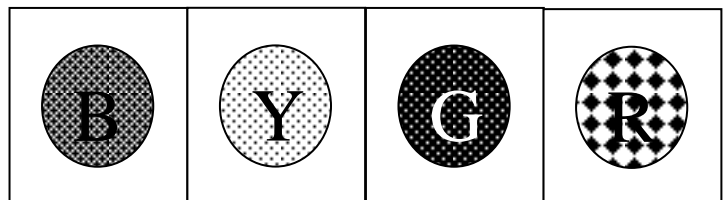
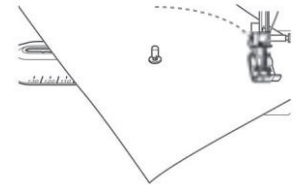

CHECKERBOARD

Supplies:

- 4 – 3” Strips of Blue
- 4 – 3” Strips of Yellow
- 4 ½” x 20 ½” – piece of purple

Sewing Steps:

- 1- Sew the Blue and yellow strips – lengthwise – alternating colors.
- 2- Press seams to the dark side (Blue)
- 3- Cut across the strips – 8 – 3” cuts
- 4- Sew them back together – alternating every other row. Press. This should measure 20 ½” square
- 5- Add the purple piece to the right side. Press. Now should be 20 ½” x 24 ½”
- 6- Add a 2 ½” x 24 ½” black sashing piece to the bottom. Press
- 7- Add the Tic-Tac-Toe Section to the sashing side.
- 8- You are thru with this section – set aside until later.

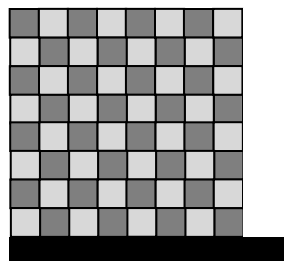
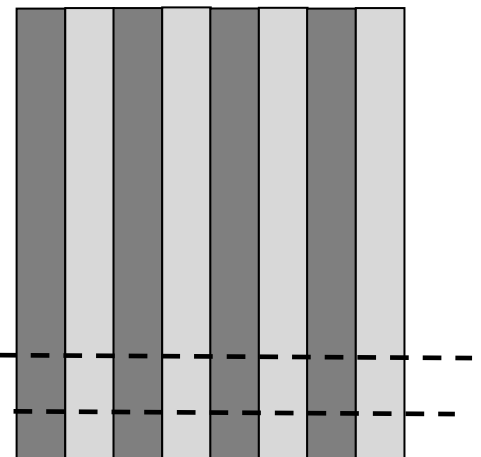
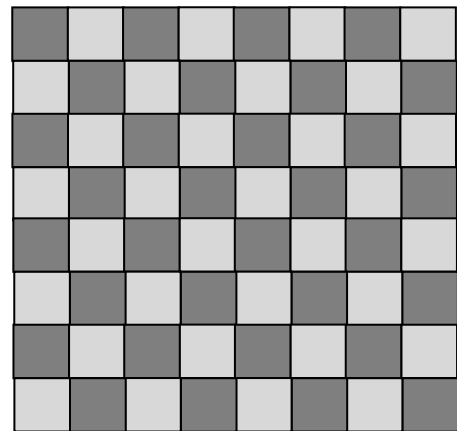

Sharman's Sewing Centers

112A Johnston St
Longview, TX 75601
903-753-8014

6005 S. Broadway
Tyler, TX 75703
903-581-5470

Appliques

*Enlarge the
Applique
pieces by
175%*



Sharman's Sewing Centers

112A Johnston St
Longview, TX 75601
903-753-8014

6005 S. Broadway
Tyler, TX 75703
903-581-5470

Enlarge the Applique pieces by 175%



Part 2 will cover the last 2 sections of the Quilt, playing pieces, and storage bags. Your Fabric Supply list should cover all the projects. This will give you a few weeks to get the big pieces finished.

